

Ruckus SmartZone Virtual SmartZone-High Scale and Virtual SmartZone-Data Plane S2a Interface Guide, 5.1.1

Supporting SmartZone 5.1.1

Copyright, Trademark and Proprietary Rights Information

© 2019 ARRIS Enterprises LLC. All rights reserved.

No part of this content may be reproduced in any form or by any means or used to make any derivative work (such as translation, transformation, or adaptation) without written permission from ARRIS International plc and/or its affiliates ("ARRIS"). ARRIS reserves the right to revise or change this content from time to time without obligation on the part of ARRIS to provide notification of such revision or change.

Export Restrictions

These products and associated technical data (in print or electronic form) may be subject to export control laws of the United States of America. It is your responsibility to determine the applicable regulations and to comply with them. The following notice is applicable for all products or technology subject to export control:

These items are controlled by the U.S. Government and authorized for export only to the country of ultimate destination for use by the ultimate consignee or end-user(s) herein identified. They may not be resold, transferred, or otherwise disposed of, to any other country or to any person other than the authorized ultimate consignee or end-user(s), either in their original form or after being incorporated into other items, without first obtaining approval from the U.S. government or as otherwise authorized by U.S. law and regulations.

Disclaimer

THIS CONTENT AND ASSOCIATED PRODUCTS OR SERVICES ("MATERIALS"), ARE PROVIDED "AS IS" AND WITHOUT WARRANTIES OF ANY KIND, WHETHER EXPRESS OR IMPLIED. TO THE FULLEST EXTENT PERMISSIBLE PURSUANT TO APPLICABLE LAW, ARRIS DISCLAIMS ALL WARRANTIES, EXPRESS OR IMPLIED, INCLUDING, BUT NOT LIMITED TO, IMPLIED WARRANTIES OF MERCHANTABILITY AND FITNESS FOR A PARTICULAR PURPOSE, TITLE, NON-INFRINGEMENT, FREEDOM FROM COMPUTER VIRUS, AND WARRANTIES ARISING FROM COURSE OF DEALING OR COURSE OF PERFORMANCE. ARRIS does not represent or warrant that the functions described or contained in the Materials will be uninterrupted or error-free, that defects will be corrected, or are free of viruses or other harmful components. ARRIS does not make any warranties or representations regarding the use of the Materials in terms of their completeness, correctness, accuracy, adequacy, usefulness, timeliness, reliability or otherwise. As a condition of your use of the Materials, you warrant to ARRIS that you will not make use thereof for any purpose that is unlawful or prohibited by their associated terms of use.

Limitation of Liability

IN NO EVENT SHALL ARRIS, ARRIS AFFILIATES, OR THEIR OFFICERS, DIRECTORS, EMPLOYEES, AGENTS, SUPPLIERS, LICENSORS AND THIRD PARTY PARTNERS, BE LIABLE FOR ANY DIRECT, INDIRECT, SPECIAL, PUNITIVE, INCIDENTAL, EXEMPLARY OR CONSEQUENTIAL DAMAGES, OR ANY DAMAGES WHATSOEVER, EVEN IF ARRIS HAS BEEN PREVIOUSLY ADVISED OF THE POSSIBILITY OF SUCH DAMAGES, WHETHER IN AN ACTION UNDER CONTRACT, TORT, OR ANY OTHER THEORY ARISING FROM YOUR ACCESS TO, OR USE OF, THE MATERIALS. Because some jurisdictions do not allow limitations on how long an implied warranty lasts, or the exclusion or limitation of liability for consequential or incidental damages, some of the above limitations may not apply to you.

Trademarks

ARRIS, the ARRIS logo, Ruckus, Ruckus Wireless, Ruckus Networks, Ruckus logo, the Big Dog design, BeamFlex, ChannelFly, EdgIron, FastIron, HyperEdge, ICX, IronPoint, OPENG, SmartCell, Unleashed, Xclaim, ZoneFlex are trademarks of ARRIS International plc and/or its affiliates. Wi-Fi Alliance, Wi-Fi, the Wi-Fi logo, the Wi-Fi CERTIFIED logo, Wi-Fi Protected Access (WPA), the Wi-Fi Protected Setup logo, and WMM are registered trademarks of Wi-Fi Alliance. Wi-Fi Protected Setup™, Wi-Fi Multimedia™, and WPA2™ are trademarks of Wi-Fi Alliance. All other trademarks are the property of their respective owners.

Contents

Preface.....	5
Document Conventions.....	5
Notes, Cautions, and Warnings.....	5
Command Syntax Conventions.....	6
Document Feedback.....	6
Ruckus Product Documentation Resources.....	6
Online Training Resources.....	7
Contacting Ruckus Customer Services and Support.....	7
What Support Do I Need?.....	7
Open a Case.....	7
Self-Service Resources.....	7
About This Guide.....	9
Overview.....	9
Terminology.....	9
References.....	10
Legend.....	10
Data Session and Path Management Messages.....	11
Overview.....	11
Data Session Establishment.....	12
Path Management Messages.....	13
Tunnel Management Messages.....	15
Create Session Process Flow.....	15
Create Session Request Messages.....	15
Bearer Context - Create Session Request.....	16
Create Session Response Messages.....	16
Bearer Context - Create Session Response Messages.....	17
Modify Bearer Command Flow.....	18
Bearer Context - Modify Bearer.....	19
Modify Bearer Request Flow.....	19
Modify Bearer Request Messages.....	19
Bearer Context - Modify Bearer Request Messages.....	20
Modify Bearer Response Message.....	20
Bearer Context - Modify Bearer Response Messages.....	21
Update Bearer Process Flow.....	21
Update Bearer Request Messages.....	21
Bearer Context - Update Bearer Request Messages.....	22
Update Bearer Response Message.....	22
Bearer Context - Update Bearer Response Message.....	22
Delete Bearer Process Flow.....	22
Delete Bearer Request Messages.....	23
Delete Bearer Response Messages.....	23
Bearer Context - Delete bearer response messages.....	24
Delete Session Process Flow.....	24
Delete Session Request Message.....	24
Delete Session Response Message.....	24

Preface

- Document Conventions..... 5
- Command Syntax Conventions..... 6
- Document Feedback..... 6
- Ruckus Product Documentation Resources..... 6
- Online Training Resources..... 7
- Contacting Ruckus Customer Services and Support..... 7

Document Conventions

The following table lists the text conventions that are used throughout this guide.

TABLE 1 Text Conventions

Convention	Description	Example
monospace	Identifies command syntax examples	<code>device(config)# interface ethernet 1/1/6</code>
bold	User interface (UI) components such as screen or page names, keyboard keys, software buttons, and field names	On the Start menu, click All Programs .
<i>italics</i>	Publication titles	Refer to the <i>Ruckus Small Cell Release Notes</i> for more information.

Notes, Cautions, and Warnings

Notes, cautions, and warning statements may be used in this document. They are listed in the order of increasing severity of potential hazards.

NOTE

A NOTE provides a tip, guidance, or advice, emphasizes important information, or provides a reference to related information.

ATTENTION

An ATTENTION statement indicates some information that you must read before continuing with the current action or task.



CAUTION

A CAUTION statement alerts you to situations that can be potentially hazardous to you or cause damage to hardware, firmware, software, or data.



DANGER

A DANGER statement indicates conditions or situations that can be potentially lethal or extremely hazardous to you. Safety labels are also attached directly to products to warn of these conditions or situations.

Command Syntax Conventions

Bold and italic text identify command syntax components. Delimiters and operators define groupings of parameters and their logical relationships.

Convention	Description
bold text	Identifies command names, keywords, and command options.
<i>italic text</i>	Identifies a variable.
[]	Syntax components displayed within square brackets are optional. Default responses to system prompts are enclosed in square brackets.
{ x y z }	A choice of required parameters is enclosed in curly brackets separated by vertical bars. You must select one of the options.
x y	A vertical bar separates mutually exclusive elements.
< >	Nonprinting characters, for example, passwords, are enclosed in angle brackets.
...	Repeat the previous element, for example, <i>member[member...]</i> .
\	Indicates a “soft” line break in command examples. If a backslash separates two lines of a command input, enter the entire command at the prompt without the backslash.

Document Feedback

Ruckus is interested in improving its documentation and welcomes your comments and suggestions.

You can email your comments to Ruckus at ruckus-docs@arris.com.

When contacting us, include the following information:

- Document title and release number
- Document part number (on the cover page)
- Page number (if appropriate)

For example:

- Ruckus SmartZone Upgrade Guide, Release 5.0
- Part number: 800-71850-001 Rev A
- Page 7

Ruckus Product Documentation Resources

Visit the Ruckus website to locate related documentation for your product and additional Ruckus resources.

Release Notes and other user documentation are available at <https://support.ruckuswireless.com/documents>. You can locate the documentation by product or perform a text search. Access to Release Notes requires an active support contract and a Ruckus Support Portal user account. Other technical documentation content is available without logging in to the Ruckus Support Portal.

White papers, data sheets, and other product documentation are available at <https://www.ruckuswireless.com>.

Online Training Resources

To access a variety of online Ruckus training modules, including free introductory courses to wireless networking essentials, site surveys, and Ruckus products, visit the Ruckus Training Portal at <https://training.ruckuswireless.com>.

Contacting Ruckus Customer Services and Support

The Customer Services and Support (CSS) organization is available to provide assistance to customers with active warranties on their Ruckus products, and customers and partners with active support contracts.

For product support information and details on contacting the Support Team, go directly to the Ruckus Support Portal using <https://support.ruckuswireless.com>, or go to <https://www.ruckuswireless.com> and select **Support**.

What Support Do I Need?

Technical issues are usually described in terms of priority (or severity). To determine if you need to call and open a case or access the self-service resources, use the following criteria:

- Priority 1 (P1)—Critical. Network or service is down and business is impacted. No known workaround. Go to the **Open a Case** section.
- Priority 2 (P2)—High. Network or service is impacted, but not down. Business impact may be high. Workaround may be available. Go to the **Open a Case** section.
- Priority 3 (P3)—Medium. Network or service is moderately impacted, but most business remains functional. Go to the **Self-Service Resources** section.
- Priority 4 (P4)—Low. Requests for information, product documentation, or product enhancements. Go to the **Self-Service Resources** section.

Open a Case

When your entire network is down (P1), or severely impacted (P2), call the appropriate telephone number listed below to get help:

- Continental United States: 1-855-782-5871
- Canada: 1-855-782-5871
- Europe, Middle East, Africa, Central and South America, and Asia Pacific, toll-free numbers are available at <https://support.ruckuswireless.com/contact-us> and Live Chat is also available.
- Worldwide toll number for our support organization. Phone charges will apply: +1-650-265-0903

We suggest that you keep a physical note of the appropriate support number in case you have an entire network outage.

Self-Service Resources

The Ruckus Support Portal at <https://support.ruckuswireless.com> offers a number of tools to help you to research and resolve problems with your Ruckus products, including:

- Technical Documentation—<https://support.ruckuswireless.com/documents>

Preface

Contacting Ruckus Customer Services and Support

- Community Forums—<https://forums.ruckuswireless.com/ruckuswireless/categories>
- Knowledge Base Articles—<https://support.ruckuswireless.com/answers>
- Software Downloads and Release Notes—https://support.ruckuswireless.com/#products_grid
- Security Bulletins—<https://support.ruckuswireless.com/security>

Using these resources will help you to resolve some issues, and will provide TAC with additional data from your troubleshooting analysis if you still require assistance through a support case or RMA. If you still require help, open and manage your case at https://support.ruckuswireless.com/case_management.

About This Guide

- Overview..... 9
- Terminology..... 9
- References..... 10
- Legend..... 10

Overview

This *Virtual SmartZone - High Scale (vSZ-H) and Virtual SmartZone-Data Plane (vSZ-D) S2a Interface Reference Guide* describes the interface between the controller and the Packet Data Network Gateway (PDN-GW). It also describes the control plane GPRS (General Packet Radio Service) tunneling protocol messages.

This guide is written for service operators and system administrators who are responsible for managing, configuring, and troubleshooting Ruckus devices. Consequently, it assumes a basic working knowledge of local area networks, wireless networking, and wireless devices.

NOTE

vSZ-H or vSZ-D is referred as *"the controller"* throughout this guide.

NOTE

If release notes are shipped with your product and the information there differs from the information in this guide, follow the instructions in the release notes.

Most user guides and release notes are available in Adobe Acrobat Reader Portable Document Format (PDF) or HTML on the Ruckus Support Web site at <https://support.ruckuswireless.com/contact-us>.

Terminology

The table below lists the terms used in this guide.

TABLE 2 Terms used in this guide

Terminology	Description
AAA	Authentication, Authorization, and Accounting
AMBR	Aggregate Maximum Bit Rate
APN	Access Point Name
DNS	Domain Name System
EBI	EPS Bearer ID
EPC	Evolved Packet Core
EPS	Evolved Packet System
F-TEID	Fully Qualified Tunnel Endpoint Identifier
GPDU	GTP Packet Data Unit
GPRS	General Packet Radio Service
GSN APN	GPRS serving node, is application module in the controller handling GTP messages
GTP	GPRS Tunneling Protocol

TABLE 2 Terms used in this guide (continued)

Terminology	Description
GTPv1-U	GTP version 1, user plane
GTPv2-C	GTP version 2, control plane
IE	Information Element
IMSI	International Mobile Subscriber Identity
IP	Internet Protocol
MCC	Mobile Country Code
MNC	Mobile Network Code
MSISDN	Mobile Subscriber ISDN Number
PAA	PDN Address Allocation
PCO	Protocol Configuration Options
PDN	Packet Data Network
PGW	PDN Gateway
SGW	Serving Gateway
ULI	User Location Information
UMTS	Universal Mobile Telecommunications Systems
UTRAN	UMTS Terrestrial Radio Access Network

References

The table below lists the specifications and standards that are referred to in this guide.

TABLE 3 References used in this guide

No.	Reference	Description
1	29274-b20.docx	<ul style="list-style-type: none"> 3GPP TS 29.274 V11.2.0 (2012-03) 3GPP Evolved Packet System (EPS) Evolved General Packet Radio Service (GPRS) Tunneling Protocol for Control plane (GTPv2-C) Stage 3 (Release 11)

Legend

The table below lists the legend/presence code used in this guide.

TABLE 4 Legends/presence code used in this guide

Legend / Presence	Description
C	Conditional
Instance Value	The Instance Value column indicates the instance number of the IE, which is used in differentiating between two instances of same IE, i.e., IE with the same type in the same message.
M	Mandatory
O	Optional

Data Session and Path Management Messages

- Overview..... 11
- Data Session Establishment..... 12
- Path Management Messages..... 13

Overview

This reference guide describes the interface between the controller with Packet Data Network Gateway (PDN-GW). It describes the control plane GPRS (General Packet Radio Service) tunneling protocol messages v2 for EPS (Evolved Packet System) interfaces (GTPv2-C) from the controller and PGW. This guide lists all the interface messages and GPRS Tunneling Protocol (GTP-C) information element used between the controller and PGW.

The S2a interface is used in control signaling between the controller and PDN-GW (Packet Data Network Gateway) as well as for tunneling end user data payload within the backbone network between both the nodes in EPC (Evolved Packet Core) network.

The GPRS Tunneling Protocol (GTP) transmits user data packets and signaling messages between the controller and PDN-GW. GTP encapsulates traffic and creates GTP tunnels, which acts as virtual data channels for transmission of packet data between the controller and PDN-GW. A GTP tunnel is established between the controller and PDN-GW through Create Session Request procedure for a data session initiated from UE.

The controller acts as trusted non-3GPP access network (TWAN) towards PDN-GW with S2a (GTPv2) interface. In case the operator EPC network does not support the S2a interface, the controller can be statically configured to support S5 (GTPv2) interface, in which case the controller acts as Serving Gateway (SGW).

A GTP tunnel is identified by a pair of IP addresses and a pair of GTP Tunnel End Point Identifiers (TEIDs), where one IP address and TEID is for the controller (TWAN) and the other is for the PGW. The TEID is a session identifier used by GTP protocol entities in the controller and in the PGW. GTP separates signaling from payload. Traffic is sorted onto a control plane (GTP-C) for signaling and a user plane (GTP-U) for user data. GTP-C is a tunnel control and management protocol and is used to create, modify and delete tunnels. GTP-U is a tunneling mechanism, which provides a service for carrying user data packets. On both planes, a GTP header encapsulates the data packet, called GTP Packet Data Unit (GPDU), and a path implemented by UDP/IP is used as bearer of the GTP traffic. Figure 1 shows the deployment of the controller in operator networks with 3G and EPC.

FIGURE 1 Deployment of controller with 3G and EPC

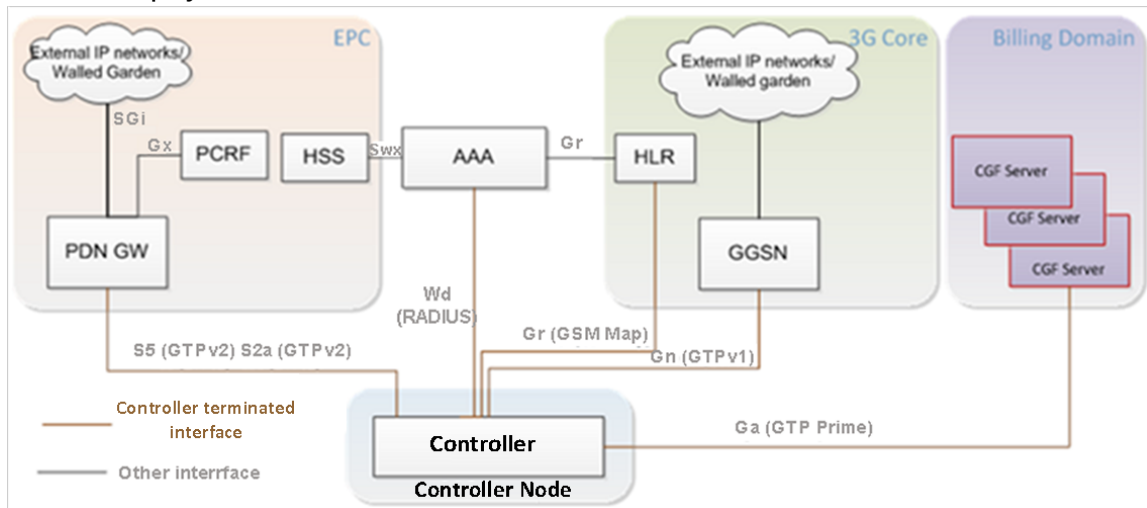

The controller supports the following categories of GTP signaling traffic:

- Path Management Messages: The main purpose of these messages is to supervise an UDP/IP path to ensure that connectivity failure can be detected on time. This is managed by frequently sending GTP Echo or Echo response packets between controller and PGW.
- Tunnel Management Messages: These contain messages that establish, modify and release GTP tunnels.

NOTE

The controller support for STA interface is being considered for the future release.

Data Session Establishment

The following figure depicts data session establishment based on the session such as create, modify, update and so on.

FIGURE 2 Data session establishment

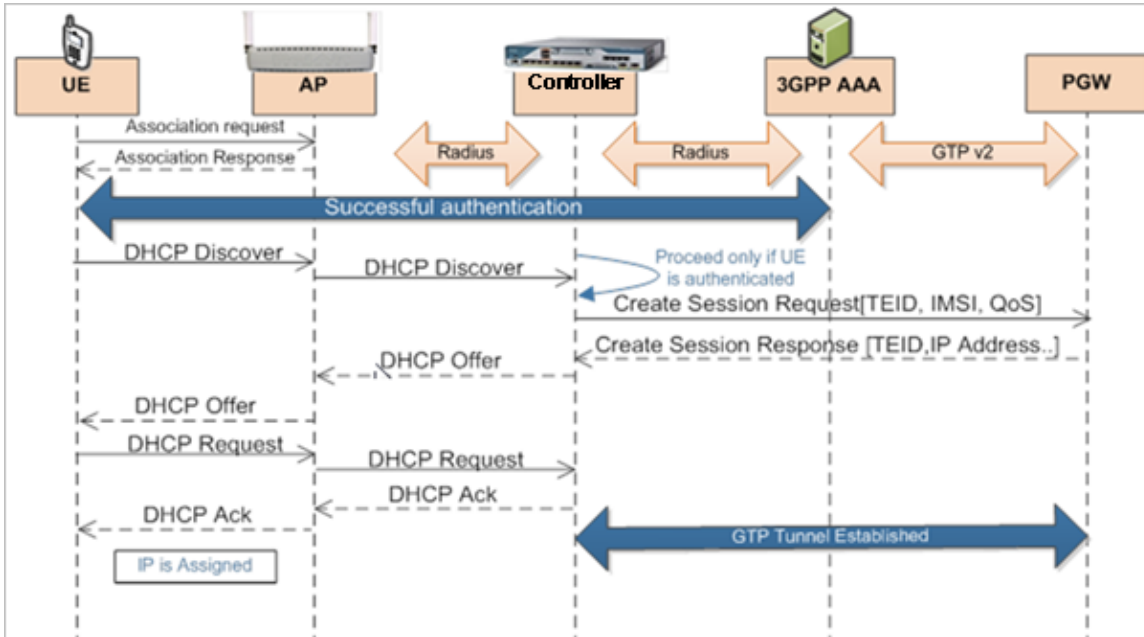

Path Management Messages

Path management messages monitor the health of the transport between GTP-C peers, which are the controller and PGW. The following figure shows the path management messages process flow and the table lists the attribute.

NOTE

GSN APP is GPRS serving node which is an application module in the controller for handling GTP messages.

FIGURE 3 Path management messages

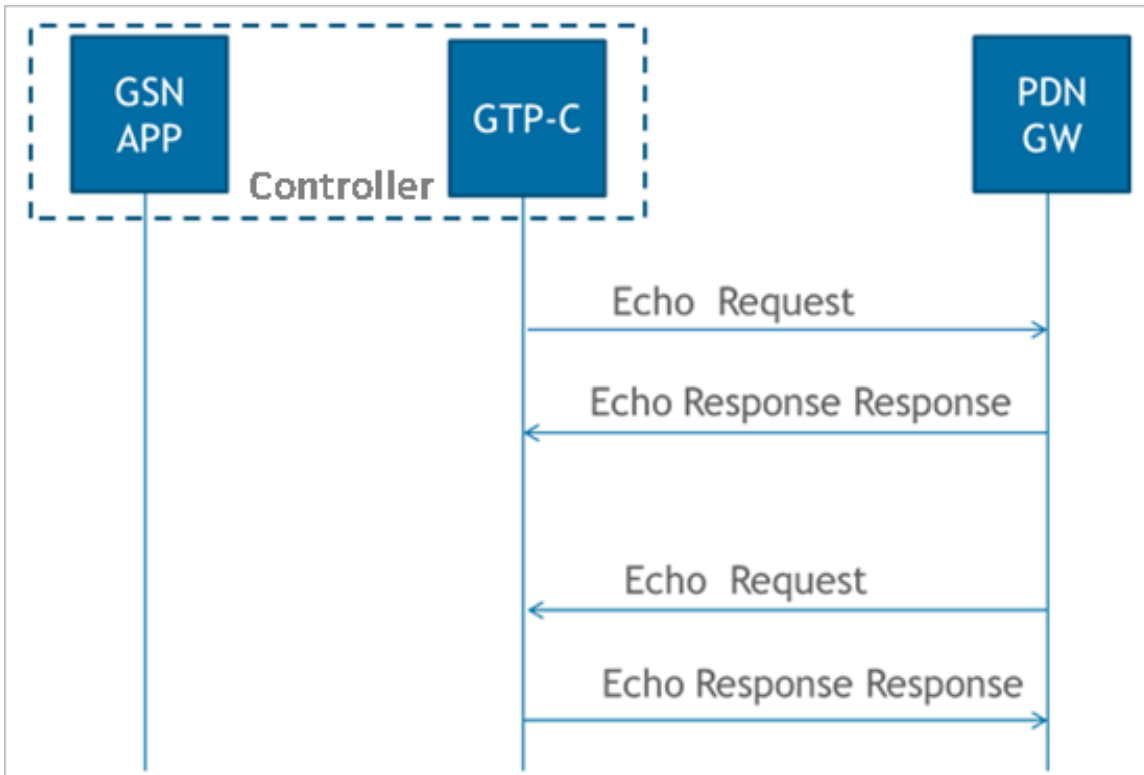

TABLE 5 Echo request message

Attribute	Presence	Comment
Recovery	M	Controllers/PGW updates the local restart counter in this IE

Tunnel Management Messages

- Create Session Process Flow..... 15
- Create Session Response Messages..... 16
- Modify Bearer Command Flow..... 18
- Modify Bearer Request Flow..... 19
- Update Bearer Process Flow..... 21
- Delete Bearer Process Flow..... 22
- Delete Session Process Flow..... 24

Create Session Process Flow

The figure below shows the process flow for create session.

FIGURE 4 Create session

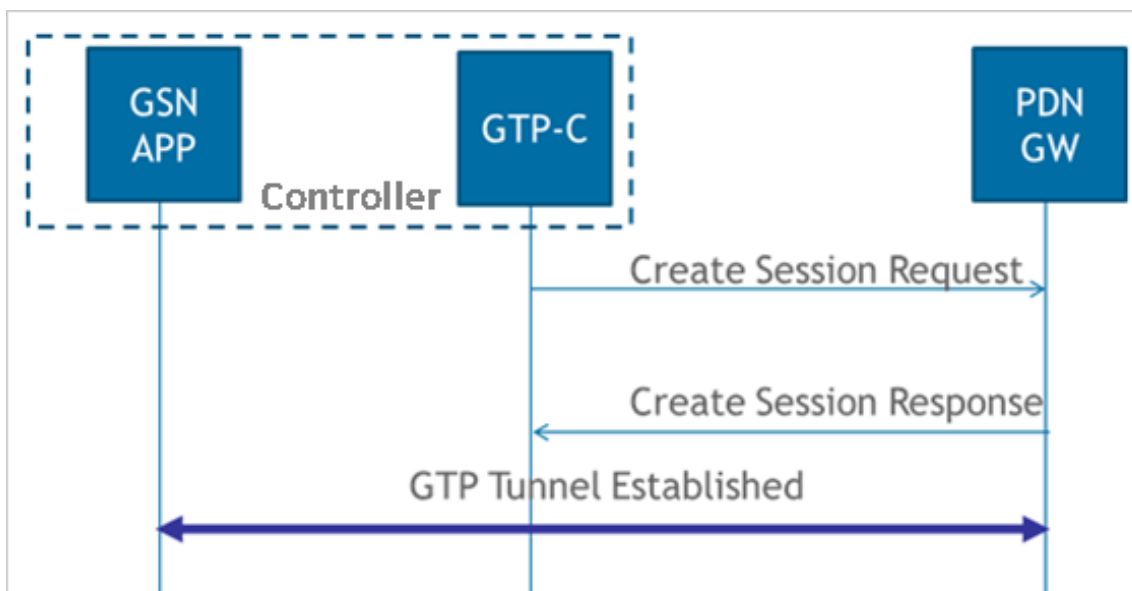

Create Session Request Messages

The table below lists the create session request messages attributes.

NOTE

The Instance Value column indicates the instance number of the IE, which is used in differentiating between two instances of same IE, i.e., IE with the same type in the same message.

TABLE 6 Create session - request messages

Attribute	Instance Value	Presence	Interface (S2a, S5 Both)	Description
IMSI	0	C	Both	IMSI of the subscriber.

TABLE 6 Create session - request messages (continued)

Attribute	Instance Value	Presence	Interface (S2a, S5 Both)	Description
MSISDN	0	C	Both	MSISDN received from AAA server during authentication.
Serving Network	0	C	Both	MCC and MNC as configured in the controller web interface. This attribute will not be present if it is not configured in the controller web interface.
RAT Type	0	M	Both	For S5 interface value is 6 (EUTRAN) and for S2a interface the value is 3 (WLAN).
Indication	0	C	Both	Value is set to zero.
F-TEID	0	M	S2a	Sender F-TEID for control plane, controller generated TEID
F-TEID	1	M	S5	Sender F-TEID for control plane, controller generated TEID
APN	0	M	Both	Access Point Name (APN), APN NI+OI
Selection Mode	0	C	Both	The value shall be set to "MS or network provided APN, subscription verified"
PDN Type	0	C	S5	Set to IPV4
PAA	0	C	Both	PDN Address allocation, set to 0.0.0.0
AMBR	0	C	Both	Aggregate Maximum Bit Rate (APN-AMBR), configurable in ttg_pdg.cfg
Bearer Context		M	Both	Bearer context is created
Recovery	0	C	Both	This attribute is included if its contacting the peer node for the first time
Maximum APN Restriction	0	C	S5	Value is set to zero, this value is set to the least restrictive type
User Location Information (ULI)	0	C	S5	User Location Information (ULI), MCC MNC from UE realm

Bearer Context - Create Session Request

The table below lists the attributes of bearer context for create session request messages.

TABLE 7 Bearer context - request messages

Attribute	Instance Value	Presence	Interface	Description
EBI	0	M	Both	EPS Bearer ID
Bearer QoS	0	M	Both	Bearer Level QoS
F-TEID	2	C	S5	S5-U SGW F-TEID
F-TEID	6	C	S2a	S2a-U TWAN F-TEID

Create Session Response Messages

The table below lists the attribute for create session response messages.

TABLE 8 Create session response message

Attribute	Instance Value	Presence	Interface (S2a, S5, Both)	Description
Cause	0	M	Both	Cause in response message.
Change Reporting Action	0	C	S5	
F-TEID	1	C	Both	Includes the TEID in the GTP based interfaces
PAA	0	C	Both	PDN Address Allocation
APN Restriction	0	C	S5	APN restriction
AMBR	0	C	Both	Aggregate Maximum Bit Rate (APN-AMBR), is included only if the received APN-AMBR is modified by the PCRF.
Charging Gateway Address	0	O	S5	PGW may include CGF IP address provided the CGF server IP address is configured in the user interface. The controller sets this server with highest priority, for sending generated CDR's.
Bearer Context	0	M	Both	Includes the QoS, Charging ID along with other attributes
Recovery	0	C	Both	Included only if the peer node is contacted for the first time.
FQDN	0	C	S5	Charging gateway name
IP Address	0	C	S5	Charging gateway address
Protocol Configuration Options (PCO)	0	O	S2a	PGW could include this IE on the S2a interface to provide TWAN with additional IP configuration parameters (example, DNS server). This IE is included provided a corresponding request is received in the Create Session - request message.
EPC Timer	0	O	S5	PGW Back-Off Time, PDN-GW rejects the Create Session Request with the cause "APN congestion". It indicates the time during which the peer should refrain from sending subsequent PDN connection establishment requests to the PGW for the congested APN for services other than Service Users/emergency services. NOTE Not supported in this release
IPv4 Configuration Parameters (IP4CP)	0	CO	S2a	Trusted WLAN IPv4 Parameters NOTE Not supported in this release
Private Extension	0	O	Both	Private Extension NOTE Not supported in this release

Bearer Context - Create Session Response Messages

The table below lists the bearer context attributes for create session response messages.

TABLE 9 Bearer context for create session response messages

Attribute	Instance Value	Presence	Interface (S2a, S5, Both)	Description
Cause	0	M	Both	Cause in response message.

TABLE 9 Bearer context for create session response messages (continued)

Attribute	Instance Value	Presence	Interface (S2a, S5, Both)	Description
EBI	0	M	Both	EPS Bearer ID
Bearer QoS	0	C	Both	Bearer Level QoS
TFT	0	O	Both	Bearer modification and TFT change
F-TEID	2	C	S5	S5-U PGW F-TEID
F-TEID	5	C	S2a	S2a-U PGWF-TEID
Charging ID	0	O	Both	Charging ID
Bearer Flag	0	O	S5	Bearer flag

Modify Bearer Command Flow

The figure below shows the modify bearer process flow. The table below lists the modify bearer attributes.

FIGURE 5 Modify bearer

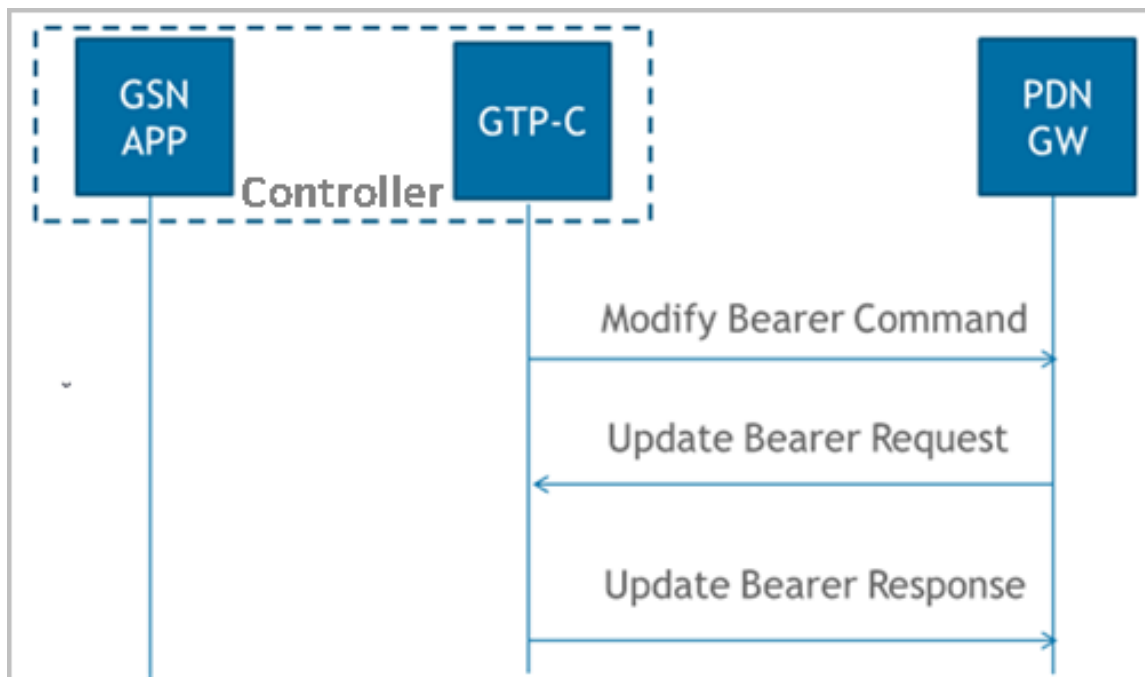

TABLE 10 Modify bearer

Attribute	Instance Value	Presence	Interface (S2a, S5, Both)	Description
Bearer Context	0	M	Both	Modified bearer context
AMBR	0	C	Both	Aggregate Maximum Bit Rate (APN-AMBR)

Bearer Context - Modify Bearer

The table below lists the attributes of bearer context.

TABLE 11 Bearer context - Modify bearer

Attribute	Instance Value	Presence	Interface (S2a, S5, Both)	Description
EBI	0	M	Both	EPS Bearer ID
Bearer QoS	0	C	Both	Bearer Level QoS

Modify Bearer Request Flow

The figure below shows the bearer process flow of request and response messages, when modified.

FIGURE 6 Modify bearer request and response messages

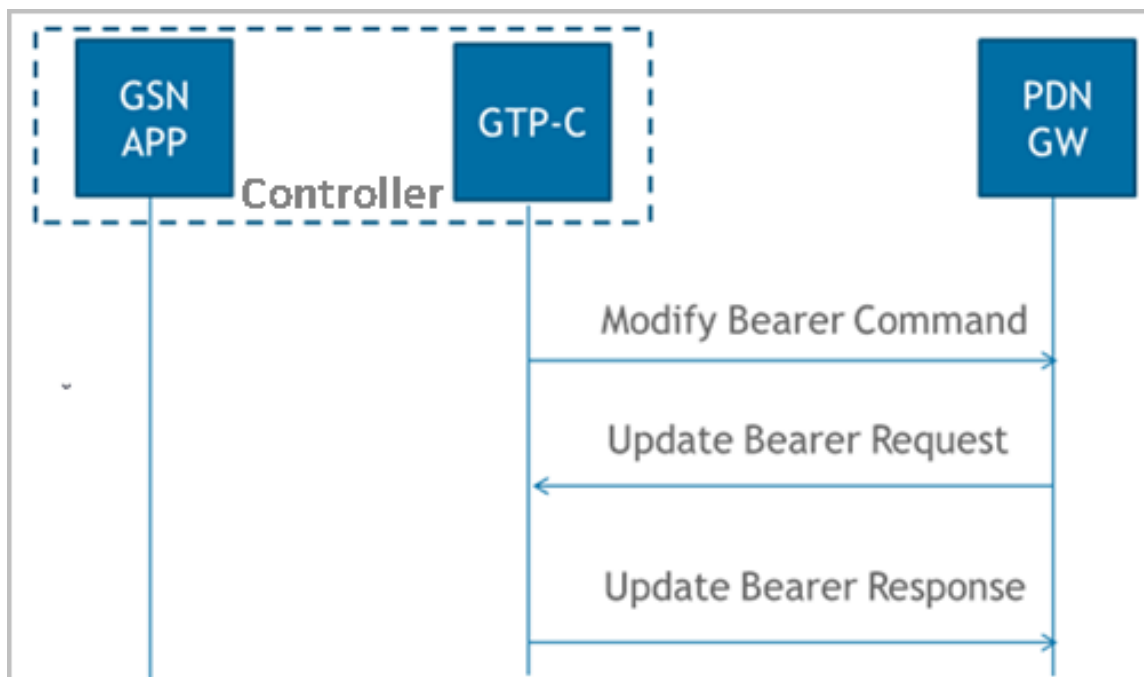

Modify Bearer Request Messages

The table below lists the attributes of modified bearer request messages.

TABLE 12 Modify bearer request messages

Attribute	Instance Value	Presence	Interface (S2a, S5, Both)	Description
ULI	0	C	S5	User Location Information
Serving Network	0	C	S5	Serving network
RAT Type	0	C	Both	For S5 the interface value is 6 (EUTRAN) and for S2a interface the value is 3 (WLAN).

TABLE 12 Modify bearer request messages (continued)

Attribute	Instance Value	Presence	Interface (S2a, S5, Both)	Description
Indication	0		Both	Indication flags
F-TEID	0		Both	Sender F-TEID for control plane
Bearer Context	0	C	Both	Bearer Contexts to be modified
Recovery	0	C	Both	Included only if the peer node is contacted for the first time.

NOTE

In release 11 specifications, *Modify Bearer Request* is not supported in an S2a interface. To support roaming scenarios Ruckus assumes that this message is required for S2a interface. Ruckus will continue with this implementation until 3GPP specification has proper roaming scenarios for S2a interface.

Bearer Context - Modify Bearer Request Messages

The table below lists the attributes of bearer context request messages for modify bearer.

TABLE 13 Bearer context - Modify bearer request messages

Attribute	Instance Value	Presence	Interface (S2a, S5, Both)	Description
EBI	0	M	Both	EPS Bearer ID
TEID	1	C	Both	Data Plane TEID

Modify Bearer Response Message

The table below lists the modified bearer response messages.

TABLE 14 Modify bearer response messages

Attribute	Instance Value	Presence	Interface (S2a, S5, Both)	Description
Cause	0	M	Both	Possible causes could be: <ul style="list-style-type: none"> Request accepted Request accepted partially Context not found Service not supported
MSISDN	0	C	Both	MSISDN
EBI	0	C	Both	Linked EPS Bearer ID
AMBR	0	C	Both	Aggregate Maximum Bit Rate (APN-AMBR), is included only if the received APN-AMBR is modified by the PCRF
Bearer Context	0	M	Both	Bearer contexts modified
Change Reporting Action	0	C	Both	
Recovery	0	C	Both	Included only if the peer node is contacted for the first time.

Bearer Context - Modify Bearer Response Messages

The table below lists the attributes of bearer context response messages for modify bearer.

TABLE 15 Bearer context - Modify bearer response messages

Attribute	Instance Value	Presence	Interface (S2a, S5, Both)	Description
EBI	0	M	Both	EPS Bearer ID
Cause	0	M	Both	Cause
Charging ID	0	O	S5	Charging ID

Update Bearer Process Flow

The table below shows the bearer process flow, when updated.

FIGURE 7 Update Bearer

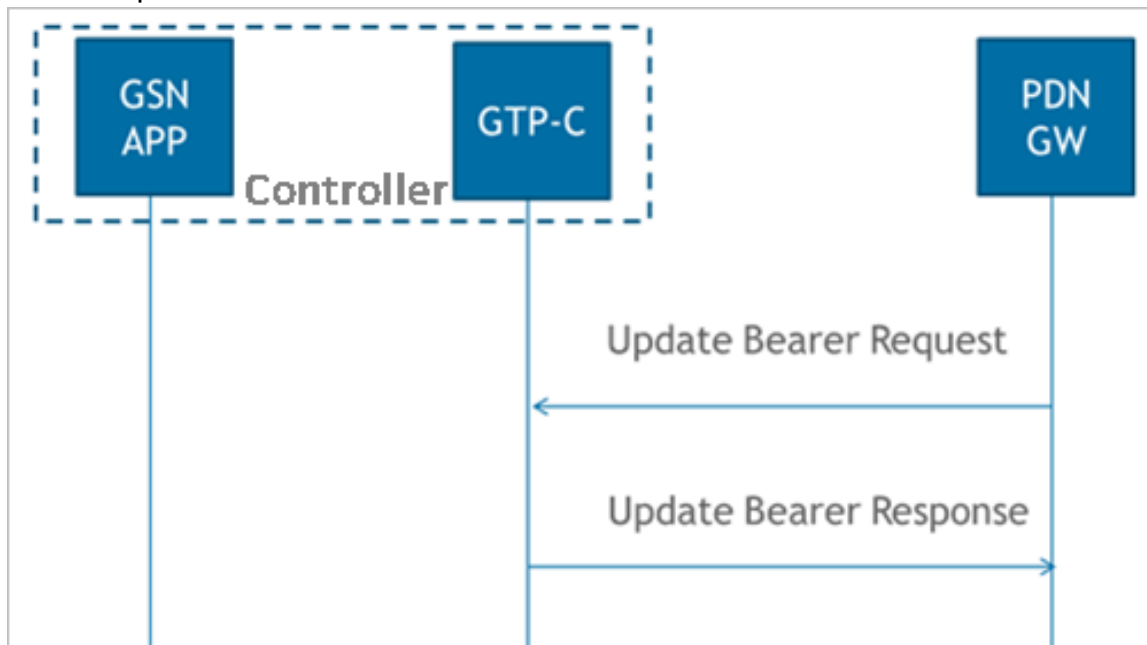

Update Bearer Request Messages

The table below lists the update bearer request messages.

TABLE 16 Update bearer request messages

Attribute	Instance Value	Presence	Interface (S2a, S5, Both)	Description
Bearer Context	0	M	Both	Modified bearer context
PCO	0	C	S5	Protocol Configuration Option
AMBR	0	C	Both	Aggregate Maximum Bit Rate (APN-AMBR)
Private Extension	0	O	Both	Private extension

Bearer Context - Update Bearer Request Messages

The table below lists the attributes of bearer context for update bearer request messages.

TABLE 17 Bearer context - Update bearer request messages

Attribute	Presence	Interface (S2a, S5, Both)	Description
EBI	M	Both	EPS Bearer ID
Bearer QoS	C	Both	Bearer level QoS
TFT	C	Both	Bearer modification and change
PCO	CO	S5	Protocol Configuration Option

Update Bearer Response Message

The table below lists the update bearer response messages.

TABLE 18 Update bearer response messages

Attribute	Presence	Interface (S2a, S5, Both)	Description
Cause	M	Both	Cause value
Bearer Context	O	Both	Failed bearer context
Recovery	C	Both	Included only if the peer node is contacted for the first time.
PCO	C/O	S5	Protocol Configuration Options (PCO) contains PCO from PCO received from PDN-GW in Create Session Response

Bearer Context - Update Bearer Response Message

The table below lists the attributes of bearer context for update bearer response message.

TABLE 19 Bearer context - Update bearer response messages

Attribute	Instance Value	Presence	Interface (S2a, S5, Both)	Description
EBI	0	M	Both	EPS Bearer ID
Cause	0	M	Both	Indicates if the bearer handling was successful and if not successful, displays the reasons
PCO	0	CO	S5	Protocol Configuration Options (PCO) contains PCO received from PDN-GW in Create Session Response

Delete Bearer Process Flow

The figure below shows the bearer process flow, when updated.

FIGURE 8 Delete bearer

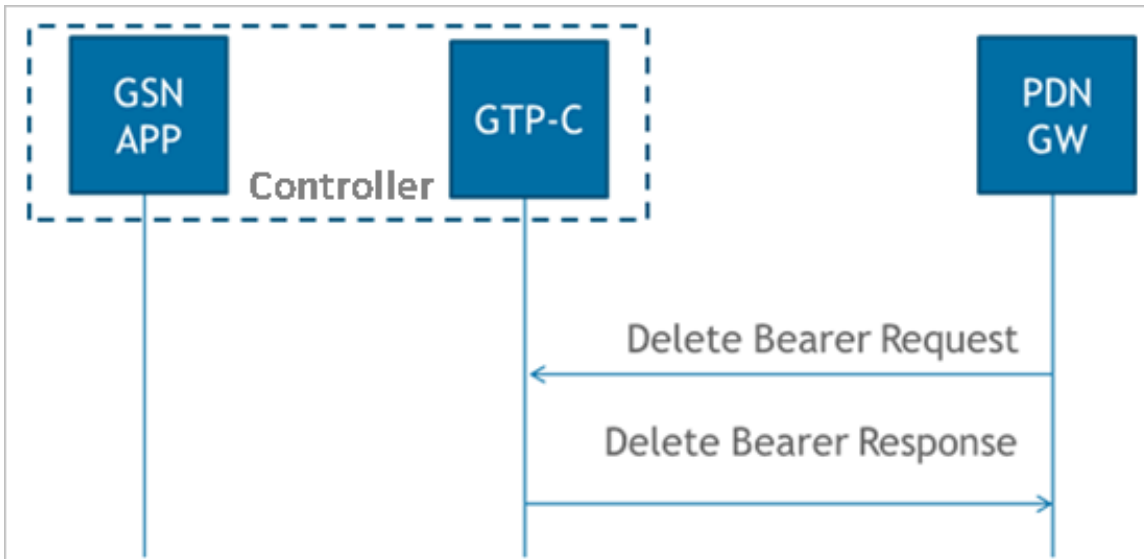

Delete Bearer Request Messages

The table below lists the delete bearer request messages.

TABLE 20 Delete bearer request messages

Attribute	Instance Value	Presence	Interface (S2a, S5, Both)	Description
EBI	0	C	Both	Linked EPS Bearer ID (LBI)
EBI	1	C	Both	EPS Bearer IDs
Bearer Context	0	O	S5	Failed bearer context
PCO	0	C	S5	Protocol Configuration Options (PCO)

Delete Bearer Response Messages

The table below lists the delete bearer response message attributes.

TABLE 21 Delete bearer response messages

Attribute	Instance Value	Presence	Interface (S2a, S5, Both)	Description
Cause	0	M	Both	Cause value
EBI	0	C	Both	Linked EPS Bearer ID (LBI)
Bearer Context	0	O	Both	Considers it as a failed bearer context when controller fails to delete the bearer
Recovery	0	C	Both	Included only if the peer node is contacted for the first time.

Bearer Context - Delete bearer response messages

The table below lists the attributes of delete bearer context.

TABLE 22 Bearer context - Delete bearer response messages

Attributes	Instance Value	Presence	Interface (S2a, S5, Both)	Description
EBI	0	M	Both	EPS Bearer ID (LBI)
Cause	0	M	Both	Indicates if the bearer handling was successful. If it is not successful, the reason is displayed.

Delete Session Process Flow

This section covers:

- [Delete Session Request Message](#) on page 24
- [Delete Session Response Message](#) on page 24

Delete Session Request Message

The table below lists the attribute for delete session request message.

TABLE 23 Delete session request messages

Attribute	Instance Value	Presence	Interface (S2a, S5, Both)	Description
EBI	0	C	Both	Linked EPS Bearer ID (LBI)

Delete Session Response Message

The table below lists the delete session response message attributes.

TABLE 24 Delete session response messages

Attribute	Instance Value	Presence	Interface (S2a, S5, Both)	Description
Cause	0	M	Both	Cause value
Recovery	0	C	Both	Included only if the peer node is contacted for the first time.
Private Extension	0	O	Both	Private extension



© 2019 ARRIS Enterprises LLC. All rights reserved.
Ruckus Wireless, Inc., a wholly owned subsidiary of ARRIS International plc.
350 West Java Dr., Sunnyvale, CA 94089 USA
www.ruckuswireless.com